





About Flexy Vacuum Cups

From my long experience buying vacuum cups, I know customers buying branded vacuum cups are paying a high price, which many realize, but they have difficulty sourcing less expensive, high quality product.

Casted PU–vacuum cups in dual durometer-style are considered the best performing polyurethane. Casted polyurethane has the ability to bridge the gap between rubber and plastic with its wide hardness range. Outstanding characteristics are tough, high abrasion resistance, fuel and oil resistance, high shock absorption, ozone and oxygen resistance, high resistance to cut initiation and cut growth. These qualities enhance life expectancy, which translates into savings in downtime.

So Flexy Vacuum Cups offers a simple opportunity:

To be your sourcing and logistic partner for high quality vacuums cups in polyurethane at competitive prices.

“ Klas Öhman, MD and owner Flexy Vacuum Cups. ”

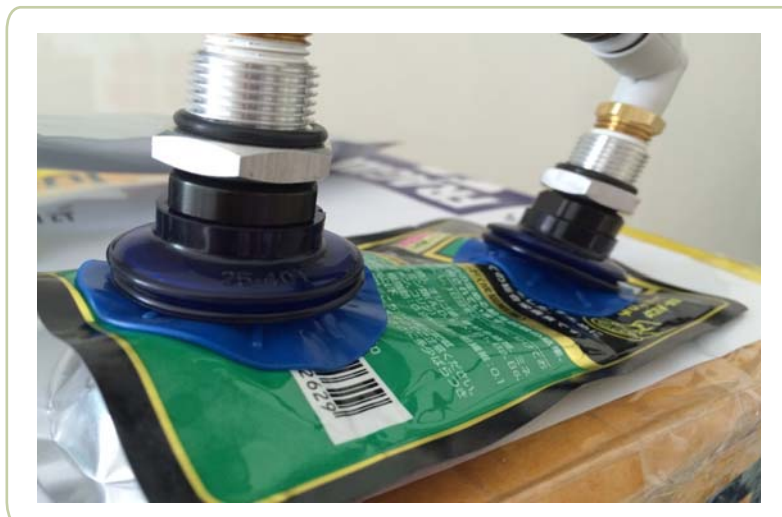



About Flexy Vacuum Cups

COMBiFlex Vacuum Cups

Our "CombiFlex" Pu cups

We also have a unique process of bonding different hardness together which means you get a firm bellow/body in combination with a soft lip. This makes the cups stable and durable with excellent sealing properties.

It is very well known among vacuum users that the bellow cups like 1.5 & 2.5 are used all over the world in different material for different applications. However bellow in Dual hardness is more rare and unique. We can now offer you to complete your existing program with dual hardness. For bigger volumes you can also get them in your own company colors and of course customize your own dual hardness cup.



Vacuum Cups Applications

Our PU vacuum cups are widely used in automated automobile assembly plants, labelling and printing, plastic, packaging, robot, medical and pharmaceutical manufacturing, materials handling and many other industrial applications where pick-and-place methods are employed.

Whether on a short or long runs, for custom or standard design we can quote customized cups from your supplied drawings.

Vacuum Knowledge

Basic Vacuum Circuit Diagrams

Vacuum Knowledge

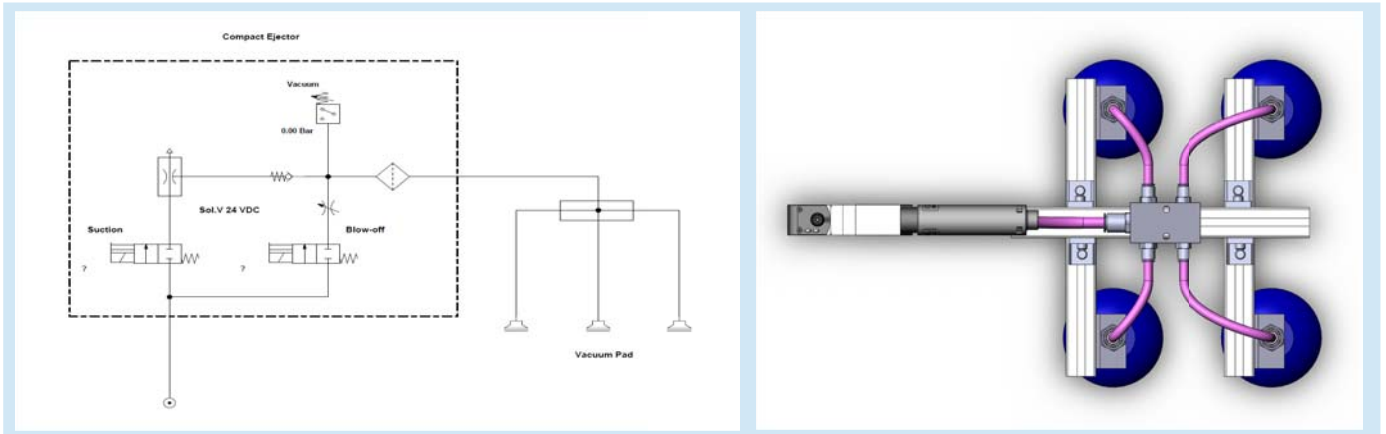

Example : Basic Vacuum Circuit Diagrams with Compact Ejector

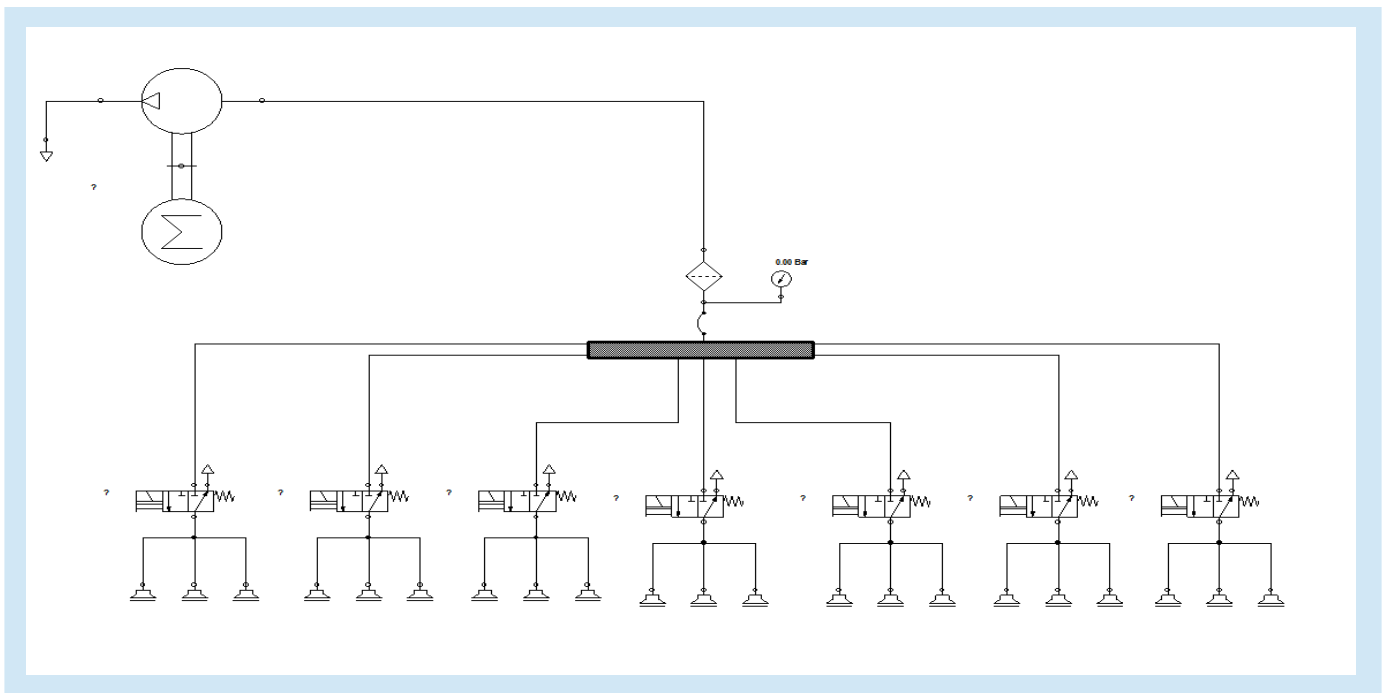

Example : Basic Vacuum Circuit Diagrams with Vacuum Pump

Vacuum Knowledge

Diameter of suction cup

Horizontal pick up :

$$d = 1.12 \times \sqrt{\frac{m \times S}{P_u \times n}}$$

Vertical pick up :

$$d = 1.12 \times \sqrt{\frac{m \times S}{P_u \times n \times \mu}}$$

d = Suction pad diameter in cm
 m = Mass of workpiece in kg
 P_u = Vacuum in bar
 n = Number of suction pads
 μ = Friction coefficient
 S = Safety factor

Calculation example for horizontal pick up :

$$d = 1.12 \times \sqrt{\frac{50 \text{ kg} \times 2}{0.4 \text{ bar} \times 4}}$$

d = **8.85 cm**

Calculation example for vertical pick up :

$$d = 1.12 \times \sqrt{\frac{50 \text{ kg} \times 2}{0.4 \text{ bar} \times 4 \times 0.5}}$$

d = **12.5 cm**

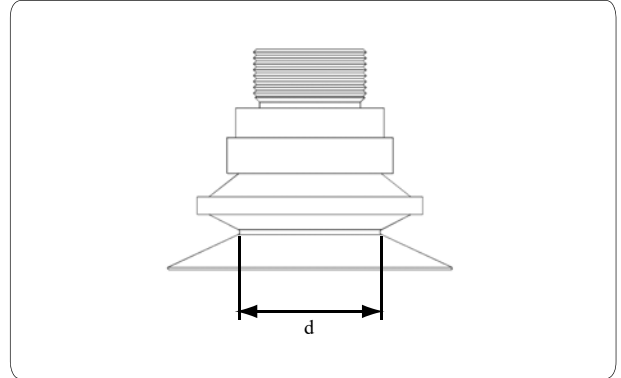

Metal sheet : m = 50 kg
 Vacuum : P_u = -0.4 bar
 Number of suction pads : n = 4
 Friction coefficient : μ = 0.5
 Safety factor : S = 2

Metal sheet : m = 50 kg
 Vacuum : P_u = -0.4 bar
 Number of suction pads : n = 4
 Friction coefficient : μ = 0.5
 Safety factor : S = 2

Diameter of vacuum hose

Diameter of distributor hose (mm) :

$$d = \frac{D}{\sqrt{n}}$$

D = Diameter of supply hose from vacuum generator (mm)
 d = diameter of distributor hose (mm)
 n = number of distributor hose
 A = area of hose (mm²)

Example 1 : How to calculate hose for distributor branch with main ID.
 D = 10 mm , number of hose n = 4

$$d = \frac{10}{\sqrt{4}}$$

d = **5 mm**

intenal diameter for distributor hose = **5 mm**

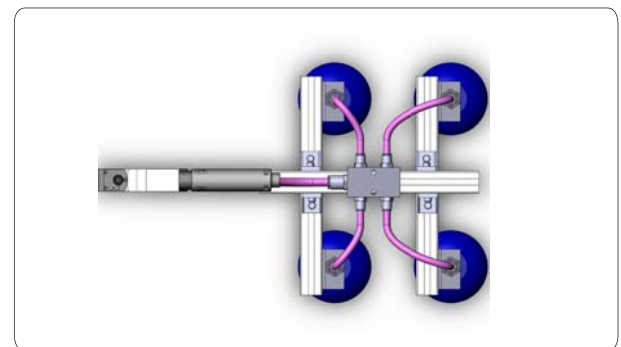

Example 2 : How to calculate hose ID main supply
 number of hose n = 4 hose, ID for distributor d= 5 mm

$$A_d = \frac{\pi d^2}{4} \times n = \frac{\pi 5^2}{4} \times 4 = 78.56 \text{ mm}^2$$

$$A_d = \frac{\pi D^2}{4}$$

$$D = \sqrt{\frac{78.56 \times 4}{\pi}} = 10 \text{ mm}$$

intenal diameter for main supply hose = **10 mm**



5 Series Flexy Gripper Flat

1 - 1



10 Series Flexy Flat

2 - 1



15 Series Flexy T - Yellow 1.5 Bellows

3 - 1



15 Series Flexy Dual Shore 1.5 Bellows

4 - 1



20 Series Flexy Traction 1.5 Bellows

5 - 1



25 Series Flexy Green Lines 2.5 Bellows

6 - 1



25 Series Flexy Dual Shore 2.5 Bellows

7 - 1



25T Series Flexy Dual Shore 2.5 Bellows Thin Lips

8 - 1



25P Series Flexy Dual Shore 2.5 Bellows Large Lips

9 - 1



25BC Series Flexy Bag Cups 2.5 Bellows

10 - 1



30 Series Flexy Friction Flat

11 - 1



vNipple M5 to G3/8"

12 - 1



Level compensator stroke 20 mm to 75 mm

13 - 1



Vacuum generator nozzle 0.9 mm

14 - 1



Vacuum generator nozzle 1 mm

15 - 1

5 Series Flexy Gripper Cups – Flat



5 Series

Vacuum Cup Properties

Material	Color	Temp. Range	Shore Hardness
Polyurethane	Dark Blue/ Yellow	5°–50°C	60° Shore A

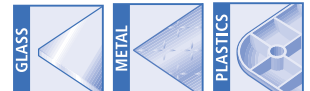

5 Series - Flexy Gripper Cups

- Our 5 Series “**Flexy Gripper**” you will find in the sizes from Ø 20 mm to Ø 120 mm .
- Normally our polyurethane vacuum cups will last 3-4 times longer than the cups made of rubber or other vulcanized materials. This means less “down time” but more “turn over” with increased productivity.
- Key characteristics are good resilience or flexibility, high tensile strength with high wear and tear resistance. Comparing to other famous brand names, our product quality is comparable or even better
- The 5 Series cups are specially designed to cope with both flat and a bit curved surfaces, particularly useful in the automotive and stamping industry. The internal cleats provide a good grip and the strengthened lip prolong the life of the cup considerably.



5 Series - Flexy Gripper Cups

Order Information

Picture	Article No.	Description	Hardness Shore A	Color	Insert / Fitting	Pcs. / Box	Dimension in mm	
	05020-01	Flexy 5-20	40	T - Yellow	25020-20 (G1/8" - M)	50	 5-20	
	05020-02		60	T - Blue				
	05030-01	Flexy 5-30	40	T - Yellow	25020-21 (G1/8" - F)		 5-30	
	05030-02		60	T - Blue				
	05040-01	Flexy 5-40	40	T - Yellow	25040-20 (G1/4" - M)		30	 5-40
	05040-02		60	T - Blue	25040-21 (G1/4" - F)			
	05060-01	Flexy 5-60	40	T - Yellow	G3/8" - M	20	 5-60	
	05060-02			T - Blue	G3/8" - F			
	05060-03		60	T - Yellow	G3/8" - M		 5-60	
	05060-04			T - Blue	G3/8" - F			
	05080-01	Flexy 5-80	40	T - Yellow	G3/8" - M	16	 5-80	
	05080-02			T - Blue	G3/8" - F			
	05080-03		60	T - Yellow	G3/8" - M		 5-80	
	05080-04			T - Blue	G3/8" - F			
	05100-01	Flexy 5-100	40	T - Yellow	G3/8" - M	10	 5-100	
	05100-02			T - Blue	G3/8" - F			
	05100-03		60	T - Yellow	G3/8" - M		 5-100	
	05100-04			T - Blue	G3/8" - F			
	05120-01	Flexy 5-120	40	T - Yellow	G3/8" - M	8	 5-120	
	05120-02			T - Blue	G3/8" - F			
	05120-03		60	T - Yellow	G3/8" - M		 5-120	
	05120-04			T - Blue	G3/8" - F			

Please notice sizes Ø20 to Ø40 are without fittings, cup Ø60 to Ø120 will come with molded insert.
 Cups will be delivered in min. quantity as per pcs/box
 For more information and dimensions please contact sales@flexyvaccumcups.com

10 Series Flexy Flat Cups



Vacuum Cup Properties

Material	Color	Temp. Range	Shore Hardness
Polyurethane	Dark Blue / Blue, Yellow	5°– 50°C	40° / 60° Shore





Flexy Flat Cups

- Our 10 Series you will find in the sizes from Ø 20 mm to Ø 80 mm, , standard hardness 40 shore A and 60 shore A. Size Ø 60 and Ø 80 standard hardness 40 shore..
- Normally our polyurethane vacuum cups will last 3-4 times longer than the cups made of rubber or other vulcanized materials. This means less "down time" but more "turn over" with increased productivity.
- The 10 series cups are specially designed to cope with flat surfaces, particularly useful in Cardboard, packaging materials , plastic sheets etc. Plastic Sheets, Metal Sheets.

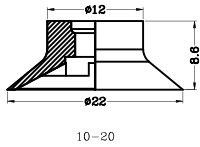
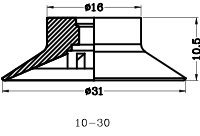
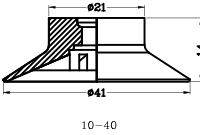

Flexy Flat Cups

Order Information

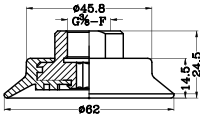
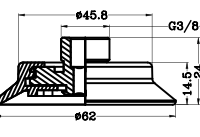
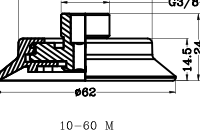
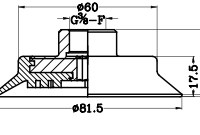
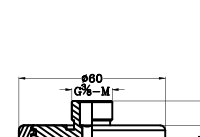
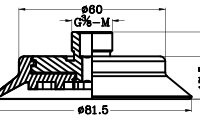
Picture	Article No.	Description	Hardness Shore A	Color	Insert / Fitting	Pcs. / Box	Dimension in mm		
	10020-01	Flexy 10-20	40	T - Yellow	25020-20 (G1/8" - M)	50			
	10020-02		60	T - Blue					
	10030-01	Flexy 10-30	40	T - Yellow	25020-21 (G1/8" - F)	30			
	10030-02		60	T - Blue					
	10040-01	Flexy 10-40	40	T - Yellow	25040-20 (G1/4" - M)	30			
	10040-02		60	T - Blue	25040-21 (G1/4" - F)				
	10060-01	Flexy 10-60	40	T - Yellow	G3/8" - M	20			
	10060-02				G3/8" - F				
	10060-03		30/60	L/D - Blue	G3/8" - M				
	10060-04				G3/8" - F				
	10060-06		40	T - Yellow	G1/4" - F				
	10060-08		30/60	L/D - Blue	G1/4" - F				
	10080-01		Flexy 10-80	40	T - Yellow		G3/8" - M	16	
	10080-02						G3/8" - F		
	10080-03	30/60		L/D - Blue	G3/8" - M				
	10080-04				G3/8" - F				
	10080-06	40		T - Yellow	G1/4" - F				
	10080-08	30/60		L/D - Blue					

Please notice sizes Ø 20 to Ø 40 are without fittings, cup Ø 60 to Ø 80 will come with molded insert.
Cups will be delivered in min. quantity as per pcs/box
For more information and dimensions please contact sales@flexyvacuumcups.com

Flexy Cups with Single Shore – 1.5 Bellows T - Yellow Line



Vacuum Cup Properties

Material	Color	Temp. Range	Shore Hardness
Polyurethane	Yellow	5°– 50°C	40° Shore A











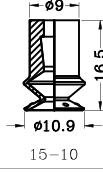

15 Series - Flexy Cups 1.5 Bellow T- Yellow Line

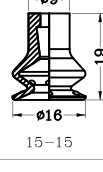
- Our 15 Series “**Flexy T - Yellow Line**” you will find in the sizes from Ø 10 mm to Ø 70 mm .
- Normally our polyurethane vacuum cups will last 3-4 times longer than the cups made of rubber or other vulcanized materials. This means less “down time” but more “turn over” with increased productivity.
- Key characteristics are good resilience or flexibility, high tensile strength with high wear and tear resistance. Comparing to other famous brand names, our product quality is comparable or even better
- The 1.5 T-yellow families is good in areas with slightly convex surfaces, compensates up to a certain degree for height differences and separation of thin materials.

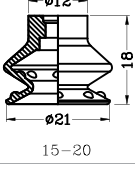

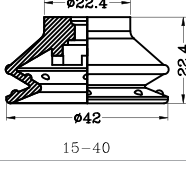
15 Series - Flexy Cups 1.5 Bellow T - Yellow Line

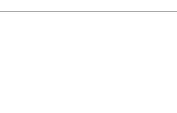
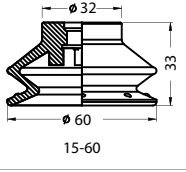
Order Information

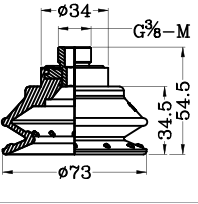
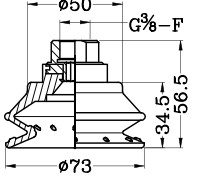
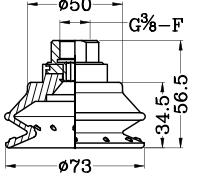
Picture	Article No.	Description	Hardness Shore A	Color	Insert / Fitting	Pcs. / Box	Dimension in mm	
	15010-08	Flexy 15-10	40	T - Yellow	15015-20 (M5,O-Ring)	25		
	15015-08	Flexy 15-15						
	15020-08	Flexy 15-20			25020-20 (G1/8" - M) 25020-21 (G1/8" - F)	50	50	
	15030-08	Flexy 15-30			25040-20 (G1/4" - M) 25040-21 (G1/4" - F)			30
	15040-08	Flexy 15-40						
	15050-08	Flexy 15-50			25050-20 (G3/8" - M) 25050-21 (G3/8" - F) 25050-22 (G1/4" - M) 25050-23 (G1/4" - F)	18	18	
	15060-08	Flexy 15-60						
	15070-18	Flexy 15-70			G3/8" - M	8	8	
	15070-19				3/8" NPFS - F			
	15070-20				G3/8" - F			

Please notice sizes Ø10 to Ø50 are without fittings, 15-70 will come with molded insert.
Cups will be delivered in min. quantity as per pcs/box
For more information and dimensions please contact sales@flexyvaccumcups.com

Flexy Dual Shore – 1.5 Bellows

Standard Vacuum Cups



COMBiFlex

Vacuum Cup Properties

Material	Color	Temp. Range	Shore Hardness
Polyurethane	Dark Blue / Blue	5°– 50°C	30° / 60°Shore



1.5 Bellow Standard Cups

- Our 1.5 family you will find in the sizes from Ø 10 mm to Ø 70 mm .
- Our CombiFlex cups you will find in standard hardness 30/60 shore A and 60 shore A. The two hardness cup 30/60 shore has a bellow in 60 shore and a lip in 30 shore, which makes the cup stable and durable with excellent sealing properties.
- Our "CombiFlex" material is **developed** to meet all the characteristics that is required for a high performance vacuum cup. Normally our polyurethane vacuum cups will last 3-4 times longer than the cups made of rubber or other vulcanized or polymerized materials. This means less "down time" but more "turn over" with increased productivity. Their key characteristics are good resilience or flexibility, high tensile strength with high wear and tear resistance. Comparing to other famous brand names, our product quality is comparable or even better. In general we are also able to keep a much more competitive price.
- The 1.5 family is good in areas with slightly convex surfaces, compensates up to a certain degree for height differences and separation of thin materials.



Flexy Standard Cups 1.5 Bellows Family

Order Information

Picture	Article No.	Description	Hardness Shore A	Color	Insert / Fitting	Pcs. / Box	Dimension in mm
	15010-06	Flexy 15-10	60	T - Blue	15015-20 (M5,O-Ring)	25	
	15015-01	Flexy 15-15	30/60	L/D - Blue			
	15015-06		60	D - Blue			
	15020-01	Flexy 15-20	30/60	L/D - Blue	25020-20 (G1/8" - M)	50	
	15020-06		60	D - Blue			
	15030-01	Flexy 15-30	30/60	L/D - Blue	25020-21 (G1/8" - F)	50	
	15030-06		60	D - Blue			
	15040-01	Flexy 15-40	30/60	L/D - Blue	25040-20 (G1/4" - M)	30	
	15040-06		60	D - Blue	25040-21 (G1/4" - F)		
	15050-01	Flexy 15-50	30/60	L/D - Blue	25050-20 (G3/8" - M)	18	
	15050-06		60	D - Blue			25050-21 (G3/8" - F)
15060-01	Flexy 15-60	30/60	L/D - Blue	25050-22 (G1/4" - M)	18		
15060-06		60	D - Blue	25050-23 (G1/4" - F)			
	15070-01	Flexy 15-70	30/60	L/D - Blue	G3/8" - M	8	
	15070-02				3/8" NPFS - F		
	15070-03				G3/8" - F		
	15070-11		30/60	D - Blue	G3/8" - M		
	15070-12		3/8" NPFS - F				
	15070-13		G3/8" - F				

Please notice sizes 10 to 50 are without fittings, cup 15-70 will come with molded insert. Height for 15-70 include insert. Cups will be delivered in min. quantity as per pcs/box
For more information and dimensions please contact sales@flexyvacuumcups.com

Flexy Traction™ CombiFlex with Single and Dual Shore – 1.5 Bellows



20 Series

COMBiFlex

Vacuum Cup Properties

Material	Color	Temp. Range	Shore Hardness
Polyurethane	Dark Blue/ Blue	5°– 50°C	30°/60° Shore A



20 Series - Flexy Traction Cups

- Our 20 Series “**Flexy Traction**” you will find in the sizes from Ø 40 mm to Ø 100 mm .
- Normally our polyurethane vacuum cups will last 3-4 times longer than the cups made of rubber or other vulcanized materials. This means less “down time” but more “turn over” with increased productivity.
- Key characteristics are good resilience or flexibility, high tensile strength with high wear and tear resistance. Comparing to other famous brand names, our product quality is comparable or even better
- The 20 Series cups are specially designed to cope with both flat and a bit curved surfaces, suitable applications are cardboards etc. The 60 shore is also useful in the stamping industry. The cleats under the lip also provide a good grip.



20 Series - Flexy Traction Cups

Order Information

Picture	Article No.	Description	Hardness Shore A	Color	Insert / Fitting	Pcs. / Box	Dimension in mm		
	20040-01	Flexy 20-40	30/60	L/D - Blue	G3/8" - M - 1/8" NPSF - F	18	 20-40 F		
	20040-02				G3/8" - F				
	20040-03				3/8" NPSF - F				
	20040-04		60	D - Blue	G3/8" - M - 1/8" NPSF - F		18	 20-40 M * 10 mm Compressed	
	20040-05				G3/8" - F				
	20040-06				3/8" NPSF - F				
	20040-07		30/60	L/D - Blue	60		D - Blue	18	 20-40 M * 10 mm Compressed
	20040-09		G1/4" - M						
			20060-01	Flexy 20-60	30/60		L/D - Blue	G3/8" - M - 1/8" NPSF - F	10
20060-02		G3/8" - F							
20060-03		3/8" NPSF - F							
20060-04		60	D - Blue		G3/8" - M - 1/8" NPSF - F	10	 20-60 M * 11.5mm Compressed		
20060-05					G3/8" - F				
20060-06					3/8" NPSF - F				
20060-07		30/60	L/D - Blue		60	D - Blue	10	 20-60 M * 11.5mm Compressed	
20060-09		G1/4" - M							
		20080-01	Flexy 20-80		30/60	L/D - Blue	G3/8" - M - 1/8" NPSF - F	8	
	20080-02	G3/8" - F							
	20080-03	3/8" NPSF - F							
	20080-04	60		D - Blue	G3/8" - M - 1/8" NPSF - F	8	 20-80 M * 15mm Compressed		
	20080-05				G3/8" - F				
	20080-06				3/8" NPSF - F				
	20080-07	30/60		L/D - Blue	60	D - Blue	8		 20-80 M * 15mm Compressed
	20080-09	G1/4" - M							
		20100-01		Flexy 20-100	30/60	L/D - Blue	G3/8" - M - 1/8" NPSF - F		8
20100-02		G3/8" - F							
20100-03		3/8" NPSF - F							
20100-04		60	D - Blue		G3/8" - M - 1/8" NPSF - F	8	 20-100 M * 18mm Compressed		
20100-05					G3/8" - F				
20100-06					3/8" NPSF - F				
20100-07		30/60	L/D - Blue		60	D - Blue	8	 20-100 M * 18mm Compressed	
20100-09		G1/4" - M							

Please notice sizes Ø40 to Ø100 will come with molded insert.
 Cups will be delivered in min. quantity as per pcs/box
 For more information and dimensions please contact sales@flexyvacuumcups.com

20 Series

Flexy Cups with Single Shore – 2.5 Bellows Green Line



25 Series Green Line

Vacuum Cup Properties

Material	Color	Temp. Range	Shore Hardness
Polyurethane	Green	5°– 50°C	50° Shore



2.5 Bellow Green Line

- Our 2.5 family Green line you will find in the sizes from Ø 15 mm to Ø 70 mm .
- Hardness 50 shore and the compound is same as the other Flexy cups.
- The compound is very durable with excellent sealing properties. 2.5 bellow cups probably one of the most sold types all over the world for general applications.
- If no special requirements as high temperature resistance etc. , those cups normally can be very good replacement for silicone, neoprene and other various compounds.
- The 2.5 family is good for use on specially curved and uneven surfaces. The double bellows suction cup is very good at compensating for a degree of difference in level and curvatures of a work piece.



Flexy Cups with Single Shore 2.5 Bellows Family Green Line

Order Information

Picture	Article No.	Description	Hardness Shore A	Color	Insert / Fitting	Pcs. / Box	Dimension in mm		
	25015-30	Flexy 25-15	50	Green	15015-20 (M5,O-Ring)	25			
	25020-30	Flexy 25-20			25020-20 (G1/8" - M)	50	25-20		
	25025-30	Flexy 25-25			25020-21 (G1/8" - F)			25-25	
	25030-30	Flexy 25-30			25030-20			25-30	
	25035-30	Flexy 25-35			25040-20 (G1/4" - M)	30	25-35		
	25040-30	Flexy 25-40			25040-21 (G1/4" - F)			25-40	
		25050-30			Flexy 25-50	25050-20 (G3/8" - M)	18	25-50	
25052-30		Flexy 25-52			25050-21 (G3/8" - F)	25-52			
					25050-22 (G1/4" - M)	25-70 F			
25050-23 (G1/4" - F)		25-70 M							

25 Series Green Line

Please notice sizes 15 to 50 are without fittings, cup 25-70 will come with molded insert. Height for 25-70 include insert. Cups will be delivered in min. quantity as per pcs/box
 For more information and dimensions please contact sales@flexyvacuumcups.com

Flexy Dual Shore – 2.5 Bellows



Standard Vacuum Cups

COMBiFlex

Vacuum Cup Properties

Material	Color	Temp. Range	Shore Hardness
Polyurethane	Dark Blue / Blue	5°– 50°C	30° / 60°Shore



2.5 Bellow Standard Cups

- Our 2.5 family you will find in the sizes from Ø 15 mm to Ø 70 mm .
- Our CombiFlex cups you will find in standard hardness 30/60 shore A and 60 shore A. The two hardness cup 30/60 shore has a bellow in 60 shore and a lip in 30 shore, which makes the cup stable and durable with excellent sealing properties.
- Our "CombiFlex " material is **developed** to meet all the characteristics that is required for a high performance vacuum cup. Normally our polyurethane vacuum cups will last 3-4 times longer than the cups made of rubber or other vulcanized or polymerized materials. This means less "down time" but more "turn over" with increased productivity. Their key characteristics are good resilience or flexibility, high tensile strength with high wear and tear resistance. Comparing to other famous brand names, our product quality is comparable or even better. In general we are also able to keep a much more competitive price.
- The 2.5 family is good for use on specially curved and uneven surfaces. The double bellows suction cup is very good at compensating for a degree of difference in level and curvatures of a workpiece.



Flexy Standard Cups 2.5 Bellows Family

Order Information

Picture	Article No.	Description	Hardness Shore A	Color	Insert / Fitting	Pcs. / Box	Dimension in mm
	25010-01	Flexy 25-10	30/60	L/D - Blue	15015-20 (M5,O-Ring)	25	 25-10
	25010-06		60	D - Blue			
	25015-01	Flexy 25-15	30/60	L/D - Blue			 25-15
	25015-06		60	D - Blue			
	25020-01	Flexy 25-20	30/60	L/D - Blue	25020-20 (G1/8" - M) 25020-21 (G1/8" - F)	50	 25-20
	25020-06		60	D - Blue			
	25025-01	Flexy 25-25	30/60	L/D - Blue			 25-25
	25025-06		60	D - Blue			
	25030-01	Flexy 25-30	30/60	L/D - Blue			 25-30
	25030-06		60	D - Blue			
	25035-01	Flexy 25-35	30/60	L/D - Blue	25040-20 (G1/4" - M) 25040-21 (G1/4" - F)	30	 25-35
	25035-06		60	D - Blue			
	25040-01	Flexy 25-40	30/60	L/D - Blue			 25-40
	25040-06		60	D - Blue			
	25050-01	Flexy 25-50	30/60	L/D - Blue	25050-20 (G3/8" - M) 25050-21 (G3/8" - F) 25050-22 (G1/4" - M) 25050-23 (G1/4" - F)	18	 25-50
	25050-06		60	D - Blue			
25052-01	Flexy 25-52	30/60	L/D - Blue	 25-52			
25052-06		60	D - Blue				

Please notice sizes 10 to 50 are without fittings, cup 25-70 will come with molded insert. Height for 25-70 include insert. Cups will be delivered in min. quantity as per pcs/box
For more information and dimensions please contact sales@flexyvacuumcups.com

Order Information

Standard Vacuum Cups

Picture	Article No.	Description	Hardness Shore A	Color	Insert / Fitting	Pcs. / Box	Dimension in mm	
	25070-01	Flexy 25-70	30/60	L/D - Blue	G3/8" - M	10		
	25070-02				3/8" NPFS - F			
	25070-03				G3/8" - F			
	25070-35		G3/8" - M - 1/8" NPFS - F					
	25070-11		60	D - Blue	G3/8" - M			
	25070-12				3/8" NPFS - F			
	25070-13				G3/8" - F			
	25075-01	Flexy 25-75	30/60	L/D - Blue	G3/8" - M			
	25075-02				3/8" NPFS - F			
	25075-03				G3/8" - F			
	25075-35		G3/8" - M - 1/8" NPFS - F					
	25075-11		60	D - Blue	G3/8" - M			
	25075-12				3/8" NPFS - F			
	25075-13				G3/8" - F			

Please notice sizes 10 to 50 are without fittings, cup 25-70 will come with molded insert. Height for 25-70 include insert. Cups will be delivered in min. quantity as per pcs/box
 For more information and dimensions please contact sales@flexyvacuumcups.com

Application Picture



Flexy 25 series dual shore for packaging industry



Flexy 25 series dual shore for plastic mold industry

Flexy Dual Shore – 2.5 Bellows - Thin Lips

25 Series



COMBiFlex

Vacuum Cup Properties

Material	Color	Temp. Range	Shore Hardness
Polyurethane	Dark Blue/ Blue	5°– 50°C	30° / 55°Shore



2.5 Bellow Vacuum Cups with Thin Lip

- Our 2.5T family you will find in the sizes from Ø 30 mm to Ø 70 mm .
- Our CombiFlex cups you will find in standard hardness 30/55 shore A and 55 shore A. The two hardness cup 30/55 shore has a bellow in 55 shore and a lip in 30 shore, which makes the cup stable and durable with excellent sealing properties.
- Our "CombiFlex " material is **developed** to meet all the characteristics that is required for a high performance vacuum cup. Normally our polyurethane vacuum cups will last 3-4 times longer than the cups made of rubber or other vulcanized or polymerized materials. This means less "down time" but more "turn over" with increased productivity. Their key characteristics are good resilience or flexibility, high tensile strength with high wear and tear resistance. Comparing to other famous brand names, our product quality is comparable or even better. In general we are also able to keep a much more competitive price.
- The 2.5 family is good for use on specially curved and uneven surfaces. The double bellows suction cup is very good at compensating for a degree of difference in level and curvatures of a work piece.



Flexy Vacm Cups 2.5 Bellows Family

Order Information

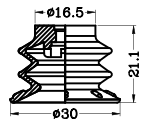
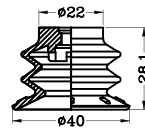
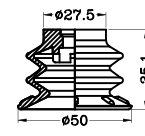
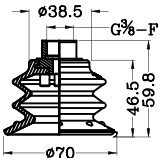
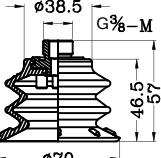
Picture	Article No.	Description	Hardness Shore A	Color	Insert / Fitting	Pcs. / Box	Dimension in mm
	25030-01T	Flexy 25-30T	30/55	L/T - Blue	25020-20 (G1/8" - M)	50	 25-30T
	25030-06T		55	T - Blue	25020-21 (G1/8" - F)		
	25040-01T	Flexy 25-40T	30/55	L/T - Blue	25040-20 (G1/4" - M)	30	 25-40T
	25040-06T		55	T - Blue	25040-21 (G1/4" - F)		
	25050-01T	Flexy 25-50T	30/55	L/T - Blue	25050-20 (G3/8" - M)	18	 25-50T
	25050-06T		55	T - Blue	25050-22 (G1/4" - M) 25050-23 (G1/4" - F)		
	25070-01T	Flexy 25-70T	30/55	L/T - Blue	G3/8 - M	10	 25-70 F
	25070-02T				3/8 NPSF - F		
	25070-03T				G3/8 - F		
	25070-11T		55	T - Blue	G3/8 - M		
	25070-12T				3/8 NPSF - F		
	25070-13T				G3/8 - F		
							 25-70 M

25 Series

Please notice sizes 30 to 50 are without fittings, cup 25-70 will come with molded insert. Height for 25-70 include insert. Cups will be delivered in min. quantity as per pcs/box
For more information and dimensions please contact sales@flexyvacuumcups.com

Flexy Picker™ CombiFlex Dual Shore – 2.5 Bellows - Large Lips

NEW!

25 Series



COMBiFlex

Vacuum Cup Properties

Material	Color	Temp. Range	Shore Hardness
Polyurethane	Yellow / Blue	5°-50°C	30° / 55°Shore

Order nipples separately.



New Combi Flex Vacuum Cups

- The two hardness cup 30/55 shore has a bellows in 55 shore and a lip in 30 shore, which makes the cup stable and durable with excellent sealing properties.
- "CombiFlex" material is developed to meet all the characteristics that is required for a high performance vacuum cup.
- Normally our polyurethane vacuum cups will last 3-4 times longer than the cups made of rubber or other vulcanized or polymerized materials. This means less "down time" but more "turn over" with increased productivity.
- Flexible sealing surface with a lighter blue 30° shore.
- Good resilience or flexibility, high tensile strength with high wear and tear resistance.
- Able to keep a much more competitive price.



Pouch or bag packaging application



Flexy Picker Cups 2.5 Bellows Family

Order Information

Picture	Article No.	Description	Hardness Shore A	Color	Insert / Fitting	Pcs. / Box	Dimension in mm
	25025-01P	Flexy 25-25P	30/55	L- Blue/ T - Yellow	25020-20 (G1/8" - M)	50	 25-25P
	25025-06P		55	T - Green			 25-25P
	25035-01P	Flexy 25-35P	30/55	L- Blue/ T - Yellow	25020-21 (G1/8" - F)	30	 25-35P
	25035-06P		55	T - Green			 25-35P
	25045-01P	Flexy 25-45P	30/55	L- Blue/ T - Yellow	25040-20 (G1/4" - M)	18	 25-45P
	25045-06P		55	T - Green	25040-21 (G1/4" - F)		 25-45P
	25055-01P	Flexy 25-55P	30/55	L- Blue/ T - Yellow	25050-20 (G3/8" - M)	15	 25-55P
	25055-06P		55	T - Green	25050-21 (G3/8" - F) 25050-22 (G1/4" - M) 25050-23 (G1/4" - F)		

Please notice sizes 25 to 55 are without fittings.
 Cups will be delivered in min. quantity as per pcs/box
 For more information and dimensions please contact sales@flexyvaccumcups.com

Flexy Bag Cup™ CombiFlex Dual Shore – 2.5 Bellows - Large Lips with Cleat

NEW!

25BC Series



COMBiFlex

Vacuum Cup Properties

Material	Color	Temp. Range	Shore Hardness
Polyurethane	Light Blue / Blue	5°-50°C	30° / 55°Shore

Order nipples separately.



New Combi Flex Vacuum Cups

- The two hardness cup 30/55 shore has a bellow in 55 shore and a lip in 30 shore, which makes the cup stable and durable with excellent sealing properties.
- "CombiFlex" material is developed to meet all the characteristics that is required for a high performance vacuum cup.
- Normally our polyurethane vacuum cups will last 3-4 times longer than the cups made of rubber or other vulcanized or polymerized materials. This means less "down time" but more "turn over" with increased productivity.
- Flexible sealing surface with a lighter blue 30° shore.
- Good resilience or flexibility, high tensile strength with high wear and tear resistance.
- Able to keep a much more competitive price.











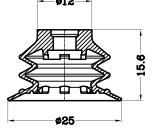

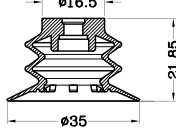

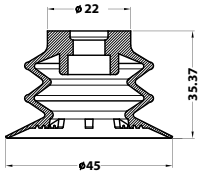

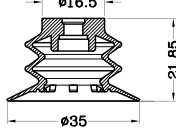

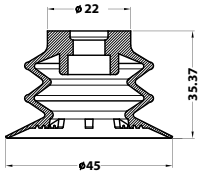
Pouch or bag packaging application

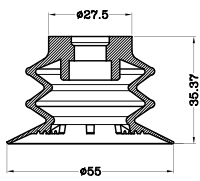

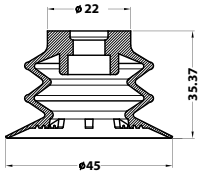
Flexy Bag Cups 2.5 Bellows Family

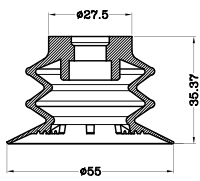
Order Information

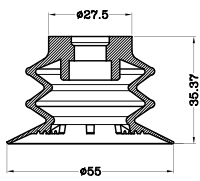
Picture	Article No.	Description	Hardness Shore A	Color	Insert / Fitting	Pcs. / Box	Dimension in mm																												
	25025-01BC	Flexy 25-25BC	30/55	L- Blue/ T - Blue	25020-20 (G1/8" - M) 25020-21 (G1/8" - F)	30																													
	25025-06BC		55	T - Blue					25035-01BC	Flexy 25-35BC	30/55	L- Blue/ T - Blue	25020-20 (G1/8" - M) 25020-21 (G1/8" - F)	30		25035-06BC	55	T - Blue		25045-01BC	Flexy 25-45BC	30/55	L- Blue/ T - Blue	25040-20 (G1/4" - M) 25040-21 (G1/4" - F)	18		25045-06BC	55	T - Blue		25055-01BC	Flexy 25-55BC	30/55	L- Blue/ T - Blue	25050-20 (G3/8" - M) 25050-21 (G3/8" - F) 25050-22 (G1/4" - M) 25050-23 (G1/4" - F)
	25035-01BC	Flexy 25-35BC	30/55	L- Blue/ T - Blue	25020-20 (G1/8" - M) 25020-21 (G1/8" - F)	30																													
	25035-06BC		55	T - Blue					25045-01BC	Flexy 25-45BC	30/55	L- Blue/ T - Blue	25040-20 (G1/4" - M) 25040-21 (G1/4" - F)	18		25045-06BC	55	T - Blue		25055-01BC	Flexy 25-55BC	30/55	L- Blue/ T - Blue	25050-20 (G3/8" - M) 25050-21 (G3/8" - F) 25050-22 (G1/4" - M) 25050-23 (G1/4" - F)	15		25055-06BC	55	T - Blue						
	25045-01BC	Flexy 25-45BC	30/55	L- Blue/ T - Blue	25040-20 (G1/4" - M) 25040-21 (G1/4" - F)	18																													
	25045-06BC		55	T - Blue					25055-01BC	Flexy 25-55BC	30/55	L- Blue/ T - Blue	25050-20 (G3/8" - M) 25050-21 (G3/8" - F) 25050-22 (G1/4" - M) 25050-23 (G1/4" - F)	15		25055-06BC	55	T - Blue																	
	25055-01BC	Flexy 25-55BC	30/55	L- Blue/ T - Blue	25050-20 (G3/8" - M) 25050-21 (G3/8" - F) 25050-22 (G1/4" - M) 25050-23 (G1/4" - F)	15																													
	25055-06BC		55	T - Blue																															

25BC Series

Please notice sizes 25 to 55 are without fittings.
Cups will be delivered in min. quantity as per pcs/box
For more information and dimensions please contact sales@flexyvacuumcups.com

Flexy Friction Flat Cups

30 Series



Vacuum Cup Properties

Material	Color	Temp. Range	Shore Hardness
Polyurethane	Dark Blue/ Yellow	5°– 50°C	55° / 60° Shore



Flexy Friction Cups

- Our 30 family you will find in the sizes Ø 80 - 100 mm .
- Our CombiFlex cups you will find in standard hardness 55/60 shore A and 60 shore A. The two hardness cup 55/60 shore has a bellow in 60 shore and a friction in 55 shore, which makes the cup stable and durable with excellent friction properties.



Flexy Friction Cups

Order Information

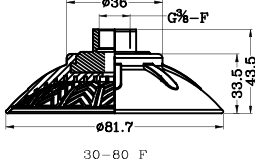
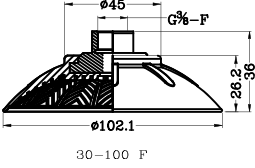
Picture	Article No.	Description	Hardness Shore A	Color	Insert / Fitting	Pcs. / Box	Dimension in mm
	30080-01	Flexy 30-80	55/60	Yellow/ T - Blue	G3/8" - M	16	
	30080-02				G3/8" - F		
	30080-03		60	T - Blue	G3/8" - M		
	30080-04				G3/8" - F		
	30100-01	Flexy 30-100	55/60	Yellow/ T - Blue	G3/8" - M	10	
	30100-02				G3/8" - F		
	30100-03		60	T - Blue	G3/8" - M		
	30100-04				G3/8" - F		

Please notice all size cup will come with molded insert.
include insert. Cups will be delivered in min. quantity as per pcs/box
For more information and dimensions please contact sales@flexyvacuumcups.com

Nipples



Nipples

Nipples Properties

Material	Color	Temp. Range
Aluminum	Black	5° - 80°C





Nipples

- Our nipples you will find in size M5 to G3/8"
- Our nipple for fit to vacuum cups
- Fittings Black anodized with locking ring and mesh filter



Nipples

Order Information

Picture	Article No.	Description	Use with Cup	Pcs. / Box	Family	Dimension in mm
	15015-20	M5, O-Ring	15-10 15-15 25-15	50	F01	
	25020-20	G1/8" - M	5-20 5-30 10-20 10-30 15-20 25-20 25-25 25-30 25-35P	50	F02	
	25020-21	G1/8" - F				
	25040-20	G1/4" - M	5-40 10-40 15-30 15-40 25-35 25-40 25-45	30	F03	
	25040-21	G1/4" - F				
	25050-20	G3/8" - M	15-50 25-50 25-55	36	F04	
	25050-21	G3/8" - F				
	25050-22	G1/4" - M			F05	
	25050-23	G1/4" - F				

For more information and dimensions please contact sales@flexyvaccumcups.com

Level Compensator

Level Compensator



Level Compensator Properties

Material	Color	Temp. Range
Steel	Silver / Blue	5° - 80°C



Level Compensator

- Our Level Compensator you will find in the stroke from 20 mm to 75 mm .
- Our Level Compensator for handling of workpieces with difference height and prevent easily damaged workpieces.
- Avialable both of internal spring and external spring







Blue External Level Compensator

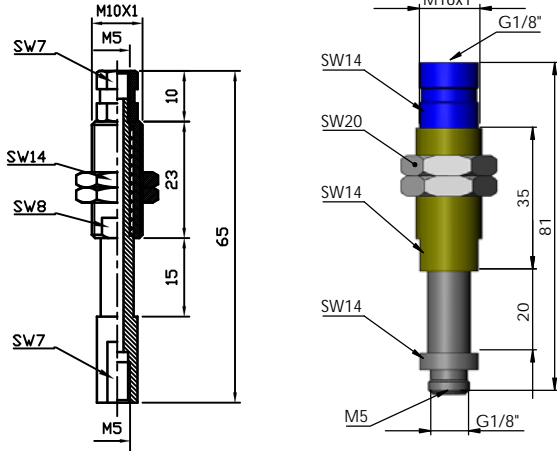

Internal Level Compensator

Order Information

Picture	Article No.	Description	Color	Dimension in mm
	SLIM515	Level Compensator M5 stroke 15 mm	Blue and Silver	
	SLI1820	Level Compensator G1/8" stroke 20 mm		
	SLE1425	Level Compensator G1/4" stroke 25 mm		
	SLE3825	Level Compensator G3/8" stroke 25 mm		
	SLE1450	Level Compensator G1/4" stroke 50 mm		
	SLE3850	Level Compensator G3/8" stroke 50 mm		
	SLE1475	Level Compensator G1/4" stroke 75 mm		
	SLE3875	Level Compensator G3/8" stroke 75 mm		

* internal spring on request

For Internal Spring on request

For more information and dimensions please contact sales@flexyvacuumcups.com

Vacuum Generator

Vacuum Generator



Vacuum Generator Properties

Material	Color	Temp. Range
Aluminum	Blue	-10° - 80°C



Vacuum Generator

- Our vacuum generator you will find in the nozzle 0.9 mm .
- Our vacuum generator use for generate vacuum by compress air.
- Optimized for all handling application



Vacuum generator medium vacuum level



Vacuum generator high vacuum level

Order Information

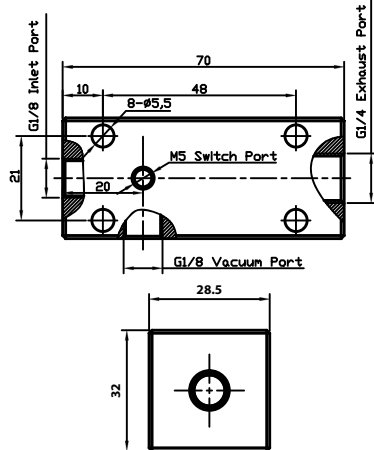
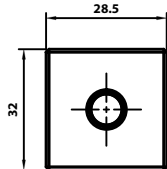
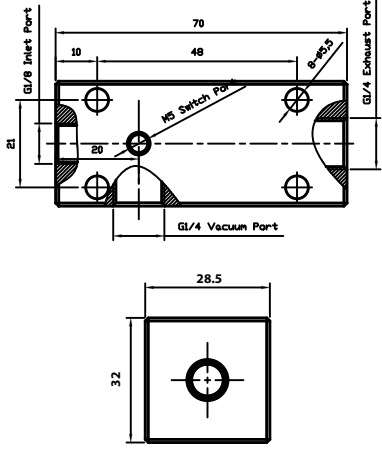
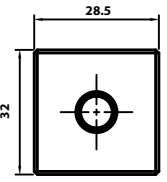
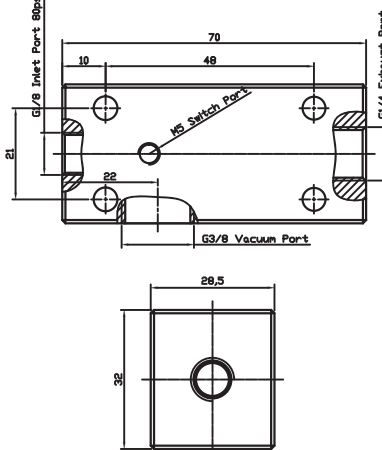
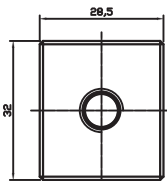
Picture	Article no.	Operate pressure (bar)	Air Consumpt. (l/min)	Suction rate (l/min)	Vacuum level (bar)	Color	Dimension in mm
	VPM-20	5	36	40	0.7	Blue	
	VPH-20	5	47	36	0.92		
	VPM-22	5	36	40	0.7		
	VPH-22	5	47	36	0.92		
	VPM-24	5	36	40	0.7		
	VPH-24	5	47	36	0.92		

For more nozzle diameter on request
 For more information and dimensions please contact sales@flexyvacuumcups.com

Vacuum Generator

Vacuum Generator



Vacuum Generator Properties

Material	Color	Temp. Range
Aluminum	Blue	-10° - 80°C



Vacuum Generator

- Our vacuum generator you will find in the nozzle 1 mm .
- Our vacuum generator use for generate vacuum by compress air.
- Optimized for all handling application



Vacuum generator high vacuum level

Order Information

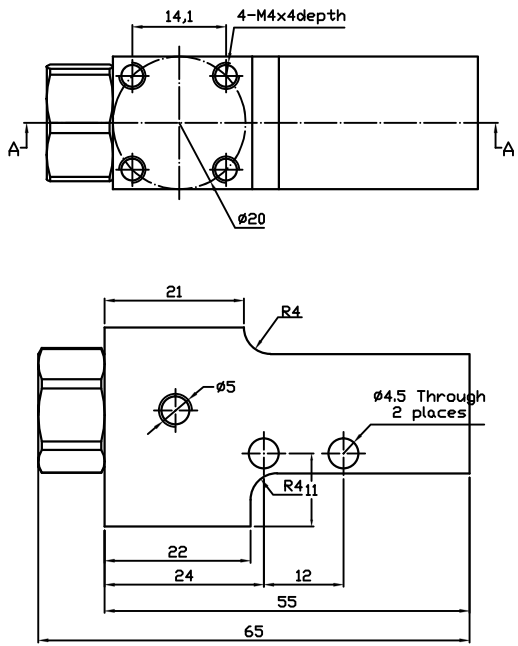
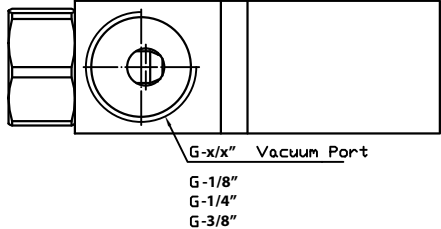
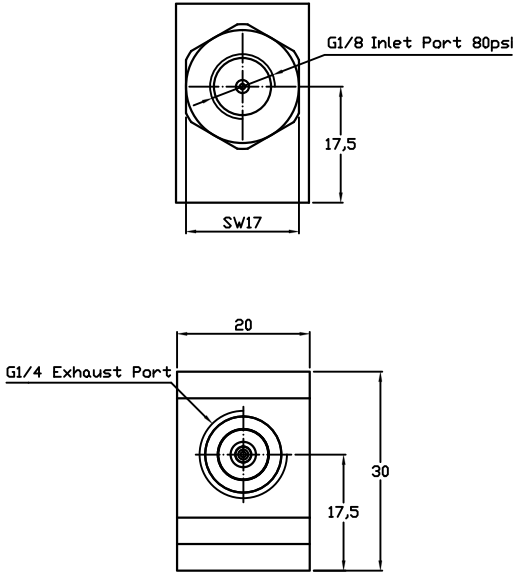
Picture	Article no.	Operate pressure (bar)	Air Consumpt. (l/min)	Suction rate (l/min)	Vacuum level (bar)	Color	Dimension in mm
	FVP-20						
	FVP-22	5	35	40	0.85	Blue	
	FVP-24						

For more nozzle diameter on request

For more information and dimensions please contact sales@flexyvaccumcups.com

